



Kahramanmaraş Sutcu Imam University

Journal of Engineering Sciences



Geliş Tarihi : 25.08.2023
Kabul Tarihi : 09.10.2023

Received Date : 25.08.2023
Accepted Date : 09.10.2023

AN EXPERIMENTAL INVESTIGATION OF THE SPEED LOSSES IN POLY-V BELT SYSTEMS ON HOUSEHOLD DRYERS

EV TİPİ KURUTUCULARDA BULUNAN POLY-V BANT SİSTEMLERİNDEKİ HIZ KAYIPLARININ DENEYSSEL OLARAK İNCELENMESİ

Mehmet MUTLUDOĞAN^{1*} (ORCID:0000-0003-2459-8708)
*Berna BOLAT*¹ (ORCID: 0000-0001-9520-7431)
*Birgül AŞÇIOĞLU TEMİZTAŞ*¹ (ORCID: 0000-0001-6785-7971)

¹ Yildiz Technical University, Department of Mechanical Engineering, Istanbul, Türkiye

*Sorumlu Yazar / Corresponding Author: Mehmet MUTLUDOĞAN, mehmet.mutludogan@std.yildiz.edu.tr

ABSTRACT

A decrease in rotational speed in gear belt systems is one of the fundamental problems that affects the efficiency of the belt. Therefore, in this study, the speed loss behavior of a Poly-V gear belt drive system with two different designs has been experimentally investigated. In the study, experiments were conducted with two different home-type dryers; one used two belts and a stepped pulley to adjust the speed, while the other used a single belt to reach the required speed. The experimental studies were conducted with two different home-type dryers. The results were analyzed using statistical methodology to determine whether the normal distribution was suitable for the measurement results, and a pairwise comparison of the speed losses in the two systems was made. Additionally, the predicted formula for loss calculation was compared with the results of variance analysis (ANOVA), and it was found that very similar results were obtained. As a result of the experimental study and analysis, it was observed that the single-belt drive system is more efficient compared to the two-belt drive system. With the efficiency curve obtained from this study, it is possible to calculate speed loss and efficiency gain for similar belt drive systems.

Keywords: Belt and pulley systems, speed losses, two sample t-test, variance analysis

ÖZET

Dişli kayış sistemlerinde dönme hızındaki azalma kayışın verimini etkileyen en temel problemlerden biridir. Bu nedenle bu çalışmada, iki farklı tasarıma sahip Poly-V dişli kayış tahrik sistemine ait hız kaybı davranışı deneysel olarak incelenmiştir. Çalışmada deneyler, iki farklı ev tipi kurutucu ile gerçekleştirildi; biri iki kayış ve kademeli bir kasnak kullanarak devri ayarlarken, diğeri gerekli devire ulaşmak için tek bir kayış kullandı. Deneysel çalışmalar iki farklı ev tipi kurutucu ile gerçekleştirilmiştir. Sonuçlar istatistiksel metodolojiye göre analiz edilerek; normal dağılımın ölçüm sonuçları için uygun olup olmadığı tespit edilerek iki sistemdeki hız kayıplarının ikili karşılaştırması yapılmıştır. Ayrıca, kayıp hesabı için öngörülen formül, varyans analizi (ANOVA) sonuçlarıyla da kıyaslanmış ve çok yakın sonuçlar elde edildiği tespit edilmiştir. Deneysel çalışma ve analizler sonucunda tek kayışlı tahrik sisteminin iki kayışlı tahrik sistemine göre daha verimli olduğu görülmüştür. Bu çalışma sonucunda elde edilen verimlilik eğrisi kullanıldığında benzer kayış tahrik sistemleri için dönüş hızı kaybı ve verimlilik kazancı hesaplanabilmektedir.

Anahtar Kelimeler: Kayış kasnak sistemleri, hız kaybı, iki örneklemlili t-testi, varyans analizi

INTRODUCTION

The concept is widely recognized that belts and pulleys usually operate under the assumption of a secure frictional connection between them. However, in certain circumstances, the frictional link weakens. This situation can lead to the driver experiencing some advancement without moving the belt along. This phenomenon, known as belt slip, is typically quantified in terms of percentage. The consequence of belt slip is a reduction in the rotational velocity of the system.

Within the scope of the literature review, studies show that two main causes of slip between a belt and pulley are defined. One of these is caused by the force-related mechanism and is formed as a function of the friction coefficient during torque transmission. The second reason is the formation of the elastic deformation shear during the winding and separation of the strap caused by the tension differences at the entrance and exit points of the belt. However, there are changes in the amount of shear between the belt and the pulley due to environmental factors as well as the effect of temperature and relative humidity on the friction coefficient between the belt and the pulley. (Uçar and Cengiz, 2007; Uçar and Cengiz, 2004).

The issue of rotational speed reduction between pulleys using flexible elastic belts, as well as the development of transmission systems aimed at curbing energy consumption, remains a topic of significant importance for industries like white goods and others. In examining the matter of rotational speed loss between pulleys, the technical literature seemed to be categorized into two distinct methodologies. One avenue involves the experimental analysis of belt systems under varying environmental conditions, while the other delves into analytical models addressing power losses in rubber V-belt systems. (Bertini et al., 2014; Zhu et al, 2010) The effect of slip between belt and pulley on power losses was experimentally investigated by several authors (Lubarda, 2015; Balta et al.; 2015(a); Balta et al., 2015; Čepon et al., 2010.), but a pairwise comparison of different Poly-V belt transmission systems is still not available. Many companies have patented designs to reduce the slip rate of the belt. However, these additional designs increase the cost. (Markus and Renhard, 2005; Kevin, 1996)

Firbank et al., considering that in the “Mechanics of The Belt Drive”, the belt is formed from a soft coating to accommodate the muscular tension with a robust pulling element (cord) for power transmission; the shear stresses in the belt envelope are an important determinant of the behavior of the mechanism and that this phenomenon is opposite to the traditional creep (elastic shift) phenomenon which is based on the longitudinal stretch of the belt (Firbank, 1970).

Gerber et al., referring to the work of K. H. Bussmann (1961) in his work “A Note On Slip in V-Belt Drives”, Bussmann experimentally proved that the slip curves for the given gentle versus slip curves are basically composed of two parts, the load in the load increases linearly with the transmitted power, whereas in the maximum power zone, it increases rapidly. In the work of B.G. Gerber's “Slip in V-Ribbed Belt Drives”, in this study where a small part of the nonlinear part of the slip curve is analyzed by the slip curve, the fast increasing section is examined in more detail, and the remarkable situation was found that when the constant a portion of the shear curve was elongated, the excessive shear was determined by the moment transmitted many times, and the belt elasticity was determined at a lesser degree. (Gerbert, 1976)

The torque load transmitted by the pulley belt system causes the forces in the belt to vary. Because of tight belt compatibility, the tension on the loose side will be different. Under the influence of the kite in a single circuit, the tight side belt speed must be higher than the slack side speed. (Grzegoek and Kot, 2016)

The provided diagram in Figure 1 illustrates distinct belt systems. These systems are comprised of two primary components: pulleys and belts. Within the scope of this study, a comparison is drawn between two belt systems. The first system encompasses two pulleys, one of which is a stepped pulley, and employs two belts. In contrast, the second system involves two pulleys connected by a single belt. All belts employed are of the Poly-V type. In industrial settings, Poly-V belts are commonly employed in conjunction with grooved disks or pulleys, as their design takes advantage of the wedging effect in the grooves to enable enhanced power transmission without slipping, surpassing the capabilities of flat belts. A comprehensive analysis of power transmission dynamics for these belt-pulley systems is conducted under conditions of external vibration, considering both micro and macro slip regions. Here, ω_1 and ω_2 denote the pulley speeds.

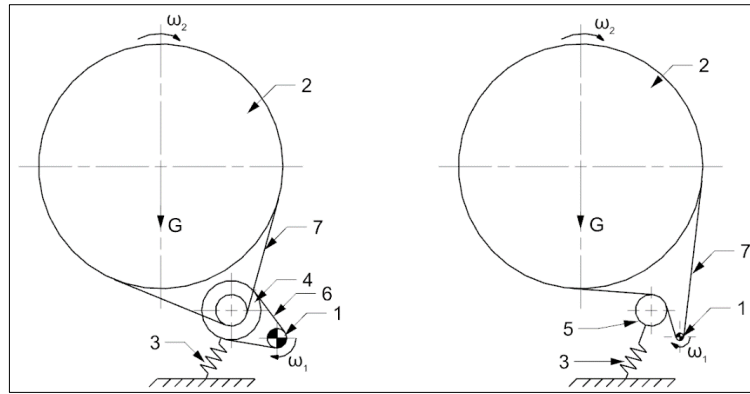

Figure 1. Physical Models of Different Belt Systems on Household Tumble Dryers. 1: Drive Pulley, 2: Tumble, 3: Spring, 4: Stepped Pulley, 5: İdler Pulley, 6: Flexible Belt, 7: Poly-V Belt

Within the fundamental principles of the belt drive system theory, the angle of winding can be categorized into the reserve angle and the active angle. Notably, alterations in belt tension, and subsequently the emergence of slip-wound spring, occur within the active segment. This disparity in speed between the driving and driven pulleys results from the relative sliding that takes place between the belt and the pulleys.

For this reason, the speed losses can be defined as:

$$Loss\% = \frac{\omega_1}{\omega_2} \times 100. \quad (1)$$

The aim of this paper is to investigate and pairwise comparison of the speed losses in Poly V belt systems on household tumble dryers with statistical analysis methodology. The results of the analysis are examined multi vari charts and other statistical tools. During the measurement, the slip rate at different loads was measured.

EXPERIMENTAL DESIGN

The aim of this study is to determine the amount of slip due to environmental conditions measured in the Poly-V belt and pulley mechanism. The working principle of the tried and tested method is based on the fact that during the operation of the Poly-V belt and pulley mechanism in different environments, the difference in the amount of rotation between the rotating pulleys is determined.

Experimental studies were conducted in a laboratory condition with 25°C and 50% relative humidity. The experimental setup comprises the tumble dryer machine, two different belt-pulley systems, a dynamic signal analyzer, an accelerometer, and a stroboscope. Figure 2 represents the experimental members.

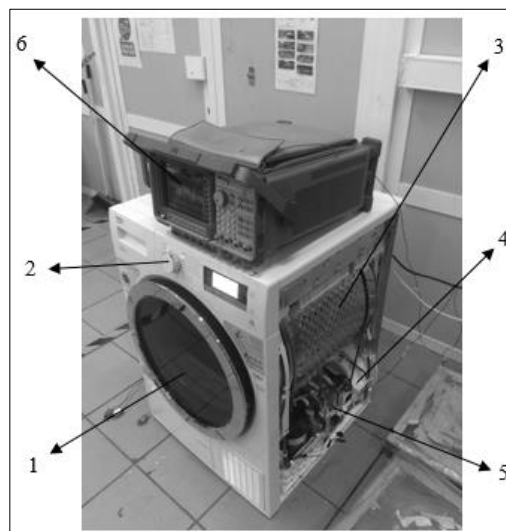

Figure 2. Test setup. 1: Tumble Dryer, 2: Control Panel, 3: Tumble, 4: Belt system, 5: Motor, 6: Dynamic Signal Analyzer

In tumbler dryer machines, there are plenty of different drying programs. An ascertainment has been done on tumble dryer programs that users frequently use. This research has been discussed with people from different age and gender groups. As a result of this observation, the most common program found out as of Cotton Cup-board Dry. All of the experiments were carried out in Cotton Cupboard Dry drying program using the same load. In this study, fixed weights were used instead of different fabric types as experiment load. The reason for this is the need to test in high weights.

The test conditions of the system are as follows; Four different weight sets were used during the experiment. These are empty weights (0 kg), weights of 14 kg, 18 kg, and 24 kg. The purpose of adding more load than the normal capacity of the machine is the desire to reveal the effect of the belt slip rate. For the design of experiments, Multilevel Factorial Design was selected. This experiment contains 2 factors, one of them 2 level and the other one 4 level. These two factorial structures reveal 8 base runs. The experiment was designed with 10 repetitions to give better results. Both belt pulley systems were cycled in 10 times drying programs with these four different weight sets. The sum of multiple experiments with two different systems, and four different weight loads, makes up to 80 experiments.

During all these experiments, the speeds of the motor, pulleys, and drums were precisely measured. In the single belt system, the drum diameter is 617 mm, and the motor shaft diameter is 11 mm. In the double belt system, the drum diameter is 617 mm, the motor shaft diameter is 22.5 mm, the idler pulley inner diameter is 33 mm, and the idler pulley outer diameter is 65 mm. Different measuring instruments have been used for measuring different sensitivities. The electric motor used in the experiment is rotating at high revs because of the 3000 rpm asynchronous electric motor. A Hewlett Packard 35670A Dynamic Signal Analyser was used to precisely measure the motor speed. The device is shown in Figure 3. Vibration from the accelerometer sensor connected to the motor and the speed at which the motor returns are calculated precisely.



Figure 3. Hewlett Packard 35670A Dynamic Signal Analyzer

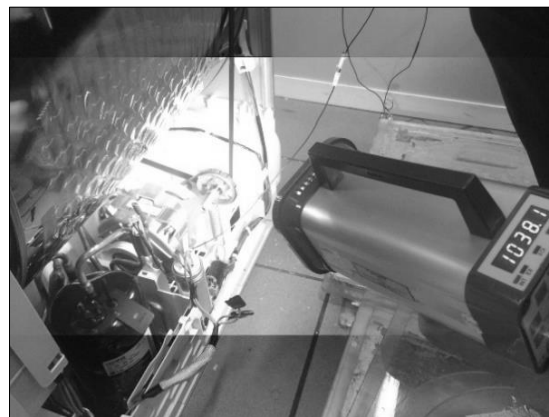

Figure 4. DT-315A Battery Powered Digital Stroboscope

Both belt pulley systems rotate at lower speeds than the electric motor. The stroboscope shown in Figure 4 is used to accurately measure the revolutions of the pulleys. Before the experiments, the pulleys were marked. When the system is started, the light pulses of the stroboscope are changed until the mark on the pulley is stable. When the mark on the pulley is seen as fixed, the number on the stroboscope indicates the speed at which the machine returns.

The drum, tumble dryer is the slowest rotating element of the drive system. In general, the number of revolutions is about 55 rpm, so it can be counted with the eye. Multiple experiments were carried out at different weight loads, and the speed of each belt pulley element was precisely calculated.

After all measurements, the theoretical number of revolutions of the drum according to the number of revolutions of the motor was compared with the measurements obtained during the experiments. In each set of experiments, the theoretical and measured revolutions were compared to find out the speed lost by % rate. All the calculated speed losses were collected by classifying the belt-pulley systems set and weights according to a table.

RESULTS AND DISCUSSION

In this paper, all the speed losses calculated after the tests are shown in Table 1. The results were analyzed according to statistical methodology.

The significance control of the difference between the two sample averages is made by one of the z or t-tests according to the sample size. With these tests, it is not possible to test two sample averages together and to check the significance of the differences between them. The variance analysis is used when testing whether the difference between two or more sample averages is significant. After the variance analysis, the t-test can be applied when the differences between the sample averages are not random.

One-way analysis of variance is a method of testing the equality of two or more averages using variances. It is used to analyze completely randomized experimental design models. In order to be able to perform two-sample variance analysis, the collected samples must meet certain assumptions.

Table 1. Results of Speed Losses Rate in Belt Systems

No	One Poly-V Belt System				Two Poly-V Belt System			
	0 Kg	14	18	24	0 Kg	14	18	24
1	2,158	3,332	3,608	4,635	2,905	3,848	4,490	4,786
2	2,165	3,575	4,301	3,949	2,902	4,178	4,522	5,190
3	2,001	3,423	5,175	2,912	2,967	4,154	4,667	4,550
4	2,348	4,037	4,450	4,606	2,849	4,165	4,239	4,634
5	2,148	3,803	3,524	4,326	3,495	4,369	3,529	4,920
6	2,235	3,639	2,334	3,918	2,716	4,107	4,857	4,492
7	2,242	2,956	2,676	5,325	2,927	4,052	4,286	5,888
8	2,253	3,956	3,750	3,164	2,954	4,192	4,616	4,081
9	2,324	3,484	5,604	4,047	2,724	4,274	3,520	6,013
10	2,203	3,336	2,743	5,575	3,592	4,226	5,058	5,815

- Both sets of populations exhibit a normal distribution.
- The samples for both groups are independently drawn from their respective populations.
- In each sample, observations are selected in a random and independent manner from one another.

For the two-sample variance test, we first examine whether the data collected from the belt pulley mechanism are appropriate for normal distribution.

The p-value and the significance level are compared to determine whether the data is following a normal distribution. A level of significance of 0.05 is selected for this study. A significance level of 0.05 indicates that 5% of the subjects did not follow a normal distribution of risk. If the p-value is less than 0.05, the regression model is statistically significant; otherwise, the variable does not have a statistically significant effect on the response parameter.

In this case, one and two poly-v belt systems are analyzed by Minitab, and the results are shown in Figure 5. According to the results, both measurements fit the normal distribution since one Poly-V belt system's p-value is 0.189 and two Poly-V belt systems' p-value is 0.071, which is greater than the significance level of 0.05.

The percentage of loss rates, normal distributions, and their averages in both belt-pulley systems are shown in Figure 6. It is seen that the normal distribution of the resultant analysis data is appropriate. When the Anderson-Darling

Normality Test analysis is performed in the normal distribution analysis of the single belt system, the mean is 3.539, st. dev. is 1.063, a-squared value is 0.73, and the p-value is 0.052. When the same test is performed on two belt systems, the mean is 3.700, st. dev. is 0,778, a-squared value is 1.26, and p-value is 0.055. Variance analysis must be done before the difference evaluation.

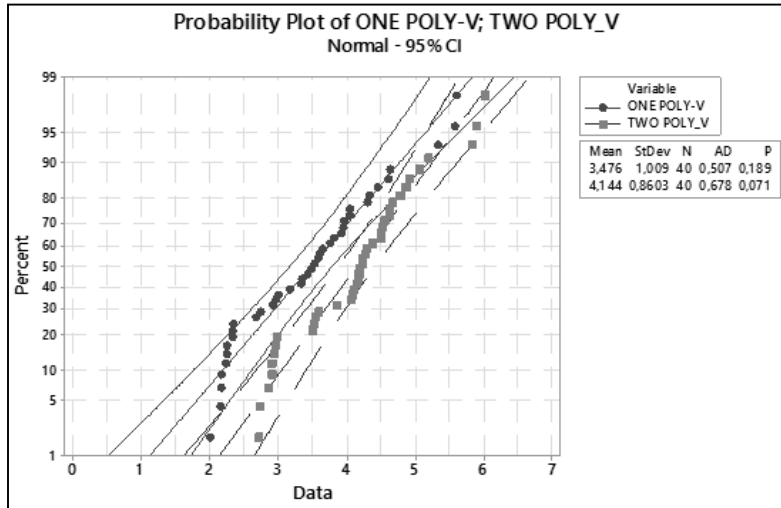

Figure 5. Probability Plot of One Poly-V and Two Poly-V Belt Systems

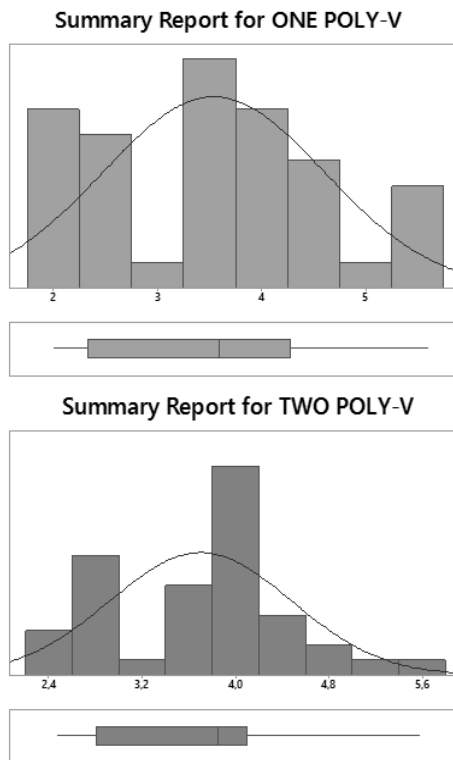

Figure 6. Summary Report for Belt Systems

The result of the analysis of variance is that although these data are randomly different but belong to a single system or they will come out from two different systems in real terms.

As shown in Figure 7, the resulting variance analysis resulted in a p-value of 0.323. Since the calculated 0.323 value is higher than 0.05, it is clear that the data belong to two different systems. In this case, Two-Sample T Tests can be used to compare two systems.

The two-sample t-test is used to determine whether two populations are equal. A common practice is to test whether a new process or system is superior to an existing process or system. As a result of the Two-Sample T-Test analysis,

the p-value is 0.002. The analysis result values are shown in Figure 8. Since the p-value is 0.002, less than 0.05 (or 5 percent), it can be concluded that there is a difference between the means.

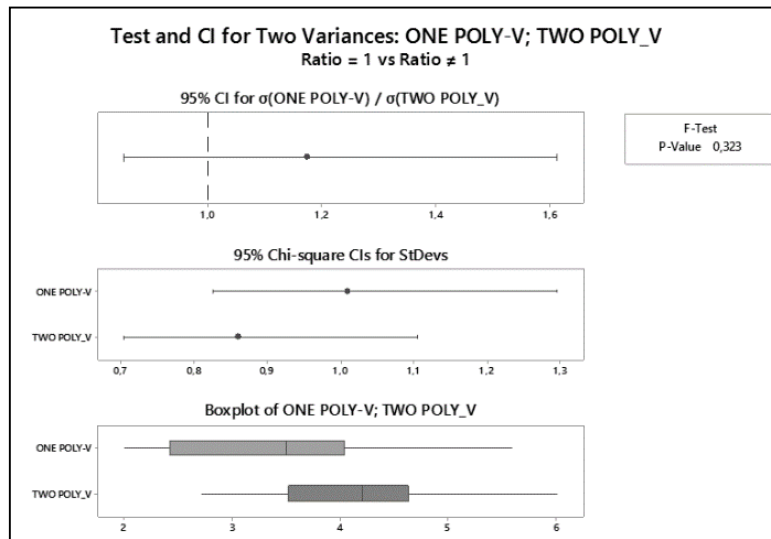

Figure 7. Test and CI for Two Variances One-Poly-V and Two-Poly-V

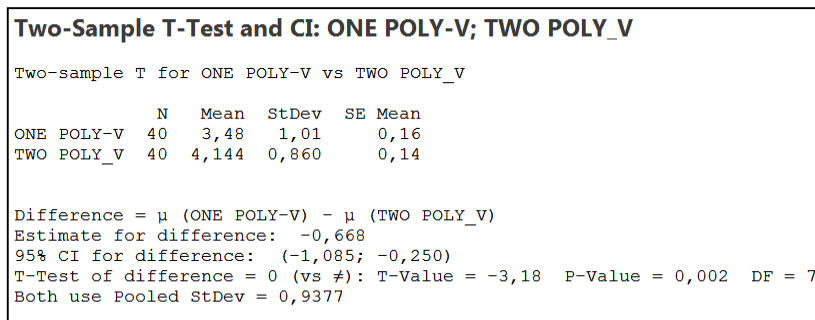

Figure 8. Two-Sample T-Test and CI: One-Poly-V; Two-Poly

As a result of the analysis, it has been found that there is a significant difference between the single-belt drive system and the two-belt drive system. As a result of the calculations made, it has been determined that the single belt system is more efficient with 19% less speed loss than the two-belt drive system. The efficiency between the systems varies according to the loads used during different experiment sets. The Multi-Vari chart is used to determine how much difference is in which load group. Figure 9 shows a graph of loss rates under different loads in two systems. As can be seen in this graph, the single belt system is more efficient in all conditions.

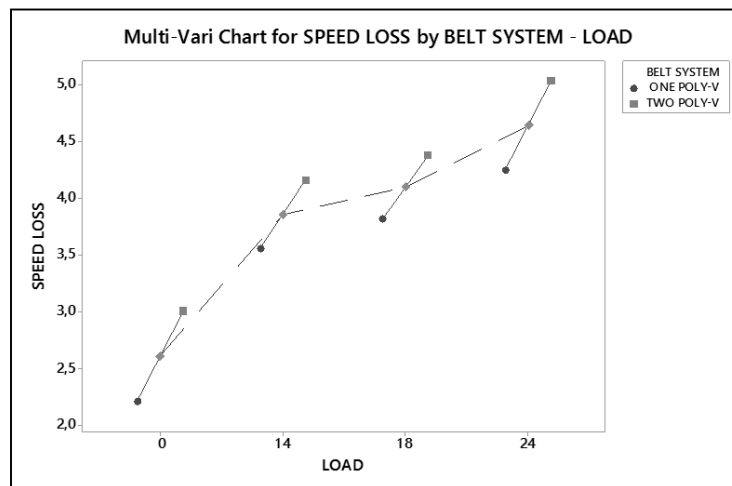

Figure 9. Probability Plot of Multi-Vari Chart for Speed Loss

Finally, the model equation (2) for the system is derived from the data obtained from the study. When the model equation and real experimental results are compared, it is seen that 96.9% of the equations are suitable.

$$SLR=1,587+(0,08438\times L)+(0,688\times NOBS) \quad (2)$$

CONCLUSIONS

In this study, the speed loss behavior of two Poly-V ribbed belt drive systems is investigated using experimental methodologies. The sum of multiple experiments with two different systems, and four different weight loads, makes up to 80 experiments. The results were analyzed according to statistical methodology and analysis of variance (ANOVA). Through the analysis of belt pulley drive systems, the following conclusions are obtained:

- 1- The resulting variance analysis resulted in a p-value of 0.323. Since the calculated 0.323 value is higher than 0.05, it is clear that the data belong to two different systems.
- 2- As a result of the analysis, it has been found that there is a significant difference between the single-belt drive system and the two-belt drive system. As a result of the calculations made, it has been determined that the single-belt system is more efficient with 19% less speed loss than the two-belt drive system.
- 3- The efficiency between the systems varies according to the loads used during different experiment sets. The maximum efficiency between the two systems appears to be 0 kg load parameter. Since the optimum operating condition of the tumble dryer is 7kg, the yield conditions in the low weight group are taken as the basis.
- 4- The single belt drive system has been selected for the tumble dryer to work more efficiently with the existing drum dimensions and electric motor.

NOMENCLATURE

$\omega_{1,2}$: Angular velocity
RPM : Revolutions Per Minute
L : Load
SLR : Speed Loss Rate
NOBS: Number of Belt Stage

ACKNOWLEDGMENT

The authors thank to Arcelik Company for their valuable assistance during the experimental procedures and support of the project.

REFERENCES

- Balta, B., Sonmez, F.O. and Cengiz, A. (2015a). Experimental identification of the torque losses in V-ribbed belt drives using the response surface method. *Journal of Automobile Engineering*, 229 (8), 1070-1082. <https://doi.org/10.1177/0954407014555150>
- Balta, B., Sonmez, F.O. and Cengiz, A. (2015b). Speed losses in V-ribbed belt drives. *Mechanism and Machine Theory*, 86, 1–14. <https://doi.org/10.1016/j.mechmachtheory.2014.11.016>
- Bertini, L., Carmignani, L. and F. Frendo F. (2014). Analytical model for the power losses in rubber V-belt continuously variable transmission (CVT). *Mechanism and Machine Theory*, 78, 289–306. <https://doi.org/10.1016/j.mechmachtheory.2014.03.016>
- Čepon, G., Manin, L., and Boltežar, M. (2010). Experimental identification of the contact parameters between a V-ribbed belt and a pulley. *Mechanism and Machine Theory*, 45, 1424–1433. <https://doi.org/10.1016/j.mechmachtheory.2010.05.006>
- Markus, F., Reinhard, H. (2005). *Bosch Siemens Hausgeraete*. WO Patent No: WO2005064065, European Patent Office.
- Firbank, T. C. (1970). Mechanics of the belt drive. *Int. J. Mech. Sci. Pergaman Press*, 12, 1053. [https://doi.org/10.1016/0020-7403\(70\)90032-9](https://doi.org/10.1016/0020-7403(70)90032-9)

- Gerbert, B. G. (1976). A note on slip in V-belt drives. *ASME Journal of Engineering for Industry*, 98(4), 1366-1368.
- Grzegoek, W. and Kot, A. (2016). The experimental analysis of the slip in the rubber belt CVT. *IOP Conference Series: Materials Science and Engineering*, 148(1). <https://doi.org/10.1088/1757-899X/148/1/012006>
- Kevin, T. (1996). *White Consolidated Ind. Inc.* US Patent No:US5501021, US Patent and Trademark Office.
- Lubarda, V.A. (2015). Determination of the belt force before the gross slip. *Mechanism and Machine Theory*, 83, 31–37. <https://doi.org/10.1016/j.mechmachtheory.2014.08.015>
- Uçar, M., Cengiz, A. (2004), V-Kayışlarda çalışma ortam şartlarının kaymaya etkisinin deneysel olarak incelenmesi. *J. Fac. Eng. Pamukkale Univ*, 10(1),137-144.
- Uçar, M., Cengiz, A. (2007). V-Kayış mekanizmalarında sıcaklık ve nemin kaymaya etkisinin deneysel incelenmesi. *J. Fac. Eng. Gazi Univ*, 22(2), 269-275.
- Zhu, C. and et al. (2010). Experimental investigation on the efficiency of the pulley-drive cvt. *International Journal of Automotive Technology*, 11(2), 257–261. <https://doi.org/10.1007/s12239-010-0032-2>